



ISTRUZIONI
SMART

1_
Decidere la posizione di fissaggio della base lavabo sulla parete.

2_
Individuare e segnare sulla parete i punti dove andranno eseguiti i fori per il fissaggio delle piastrine **(P)** di sostegno.

3_
Con un trapano forare il muro, il diametro dei fori deve essere uguale a quello dei tasselli.
Onde evitare qualsiasi problema di ancoraggio, si consigliano tasselli idonei al tipo di muro.

Attenzione! Si consiglia di verificare la corretta tenuta del muro prima di agganciare le basi sospese. (Cartongesso non idoneo, se non rinforzato nei punti di ancoraggio)

4_
Agganciare la base sulle piastrine di sostegno con le attaccaglie **(A)**.

5_
Regolare l'altezza della base agendo sulla vite **(1)** mediante un cacciavite. (vedi pagine successive)

6_
Regolare il distacco dalla parete agendo sulla vite **(2)** mediante un cacciavite. (vedi pagine successive)

7_
Verificare la messa in bolla della base con la livella, agendo sempre sulle viti di regolazione **(1)** e **(2)**

La messa in bolla della base è importantissimo per evitare il mal funzionamento di ante e cassetti.

STRUMENTI DI LAVORO (Se ne raccomanda un utilizzo corretto, per un perfetto fissaggio)



PERCORSO DI LAVORO

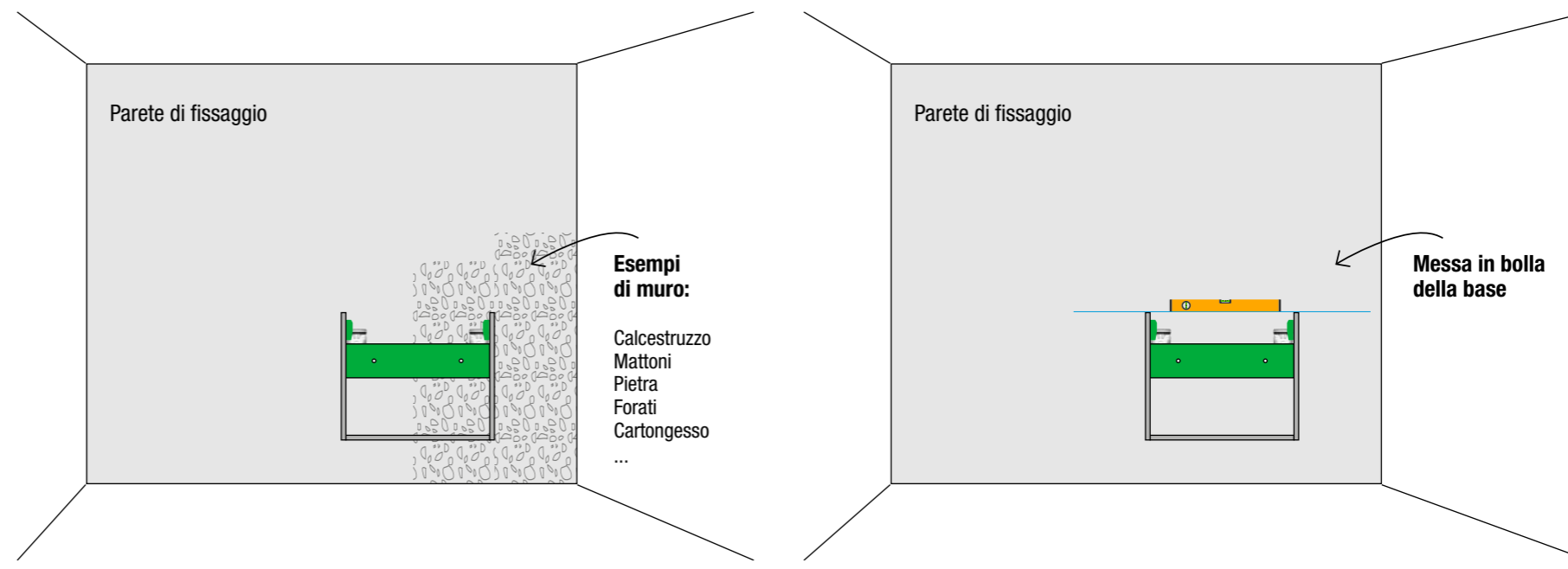
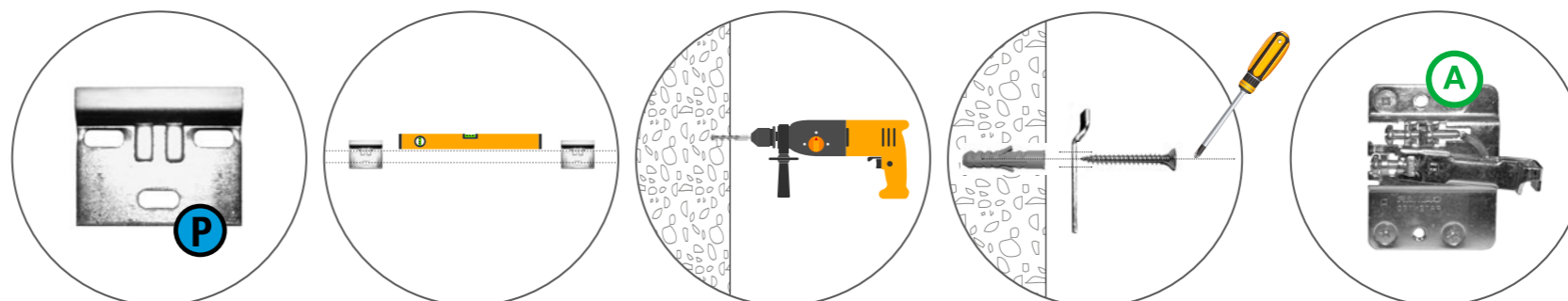

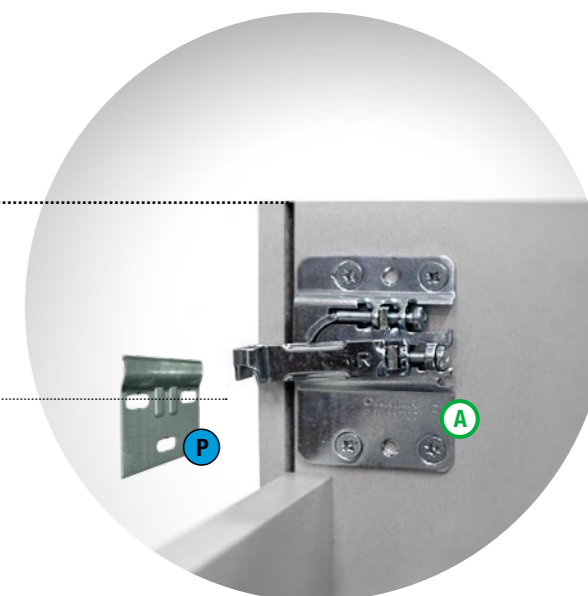
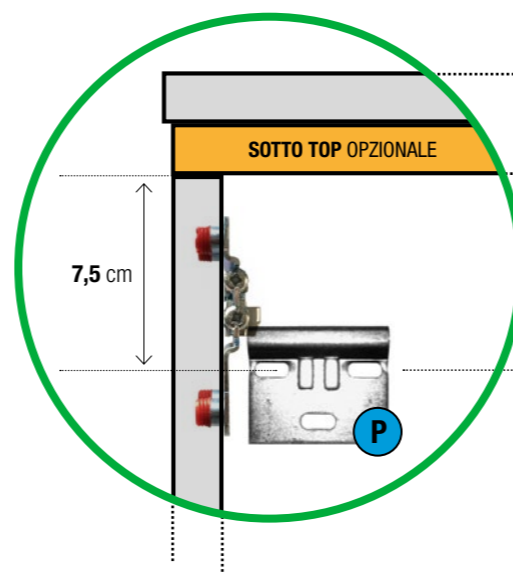
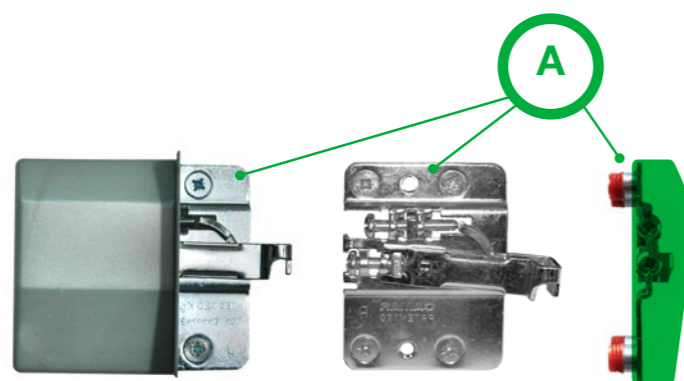
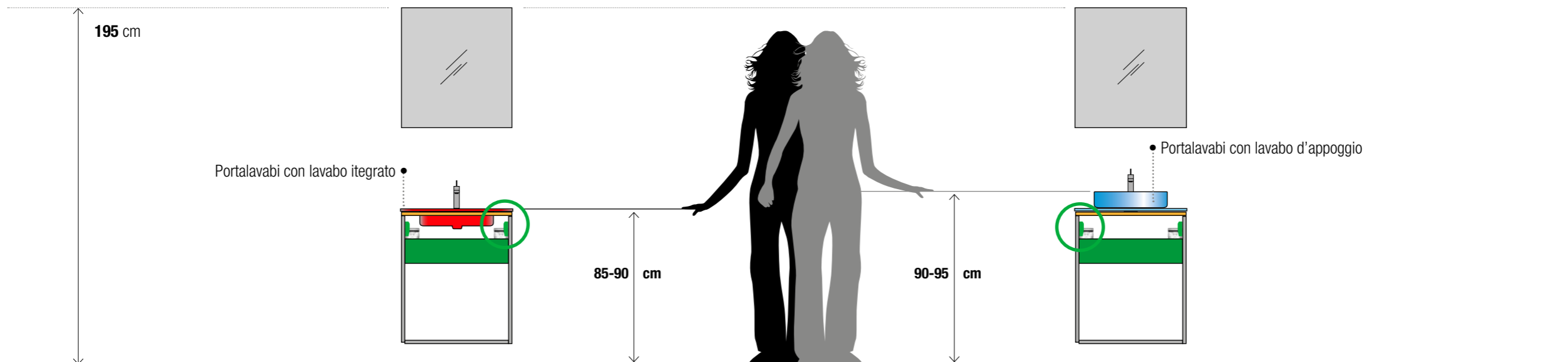

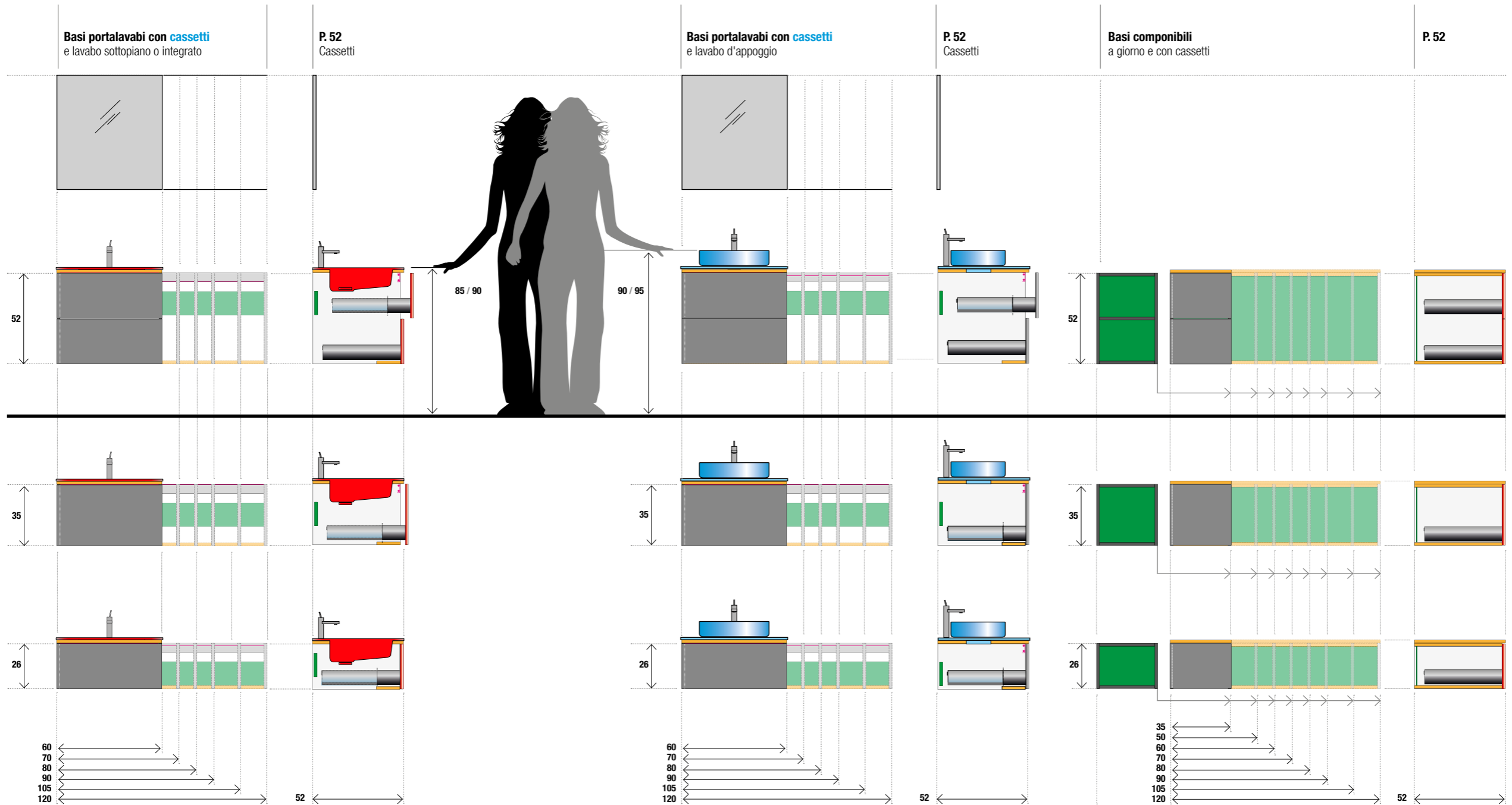

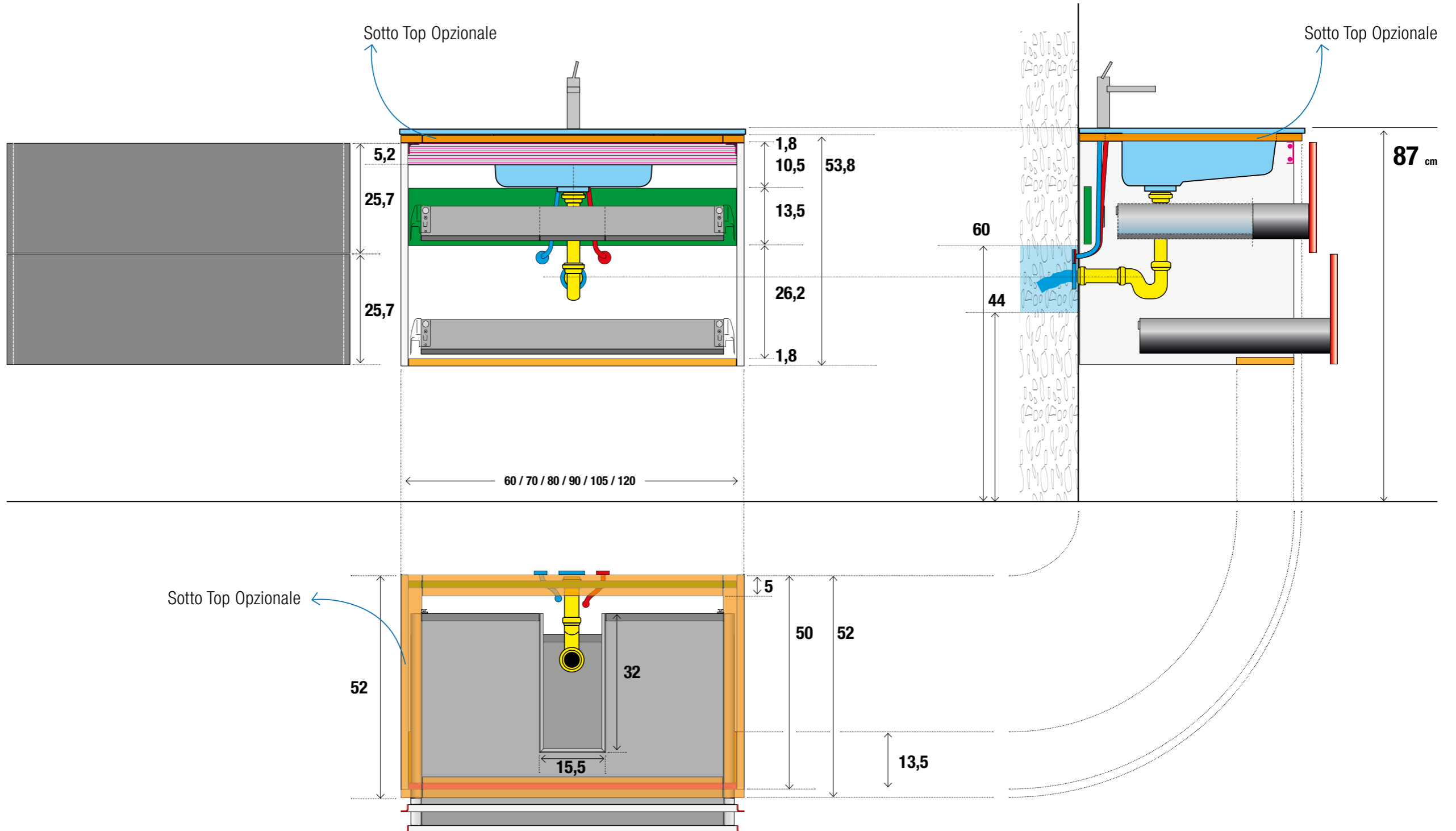

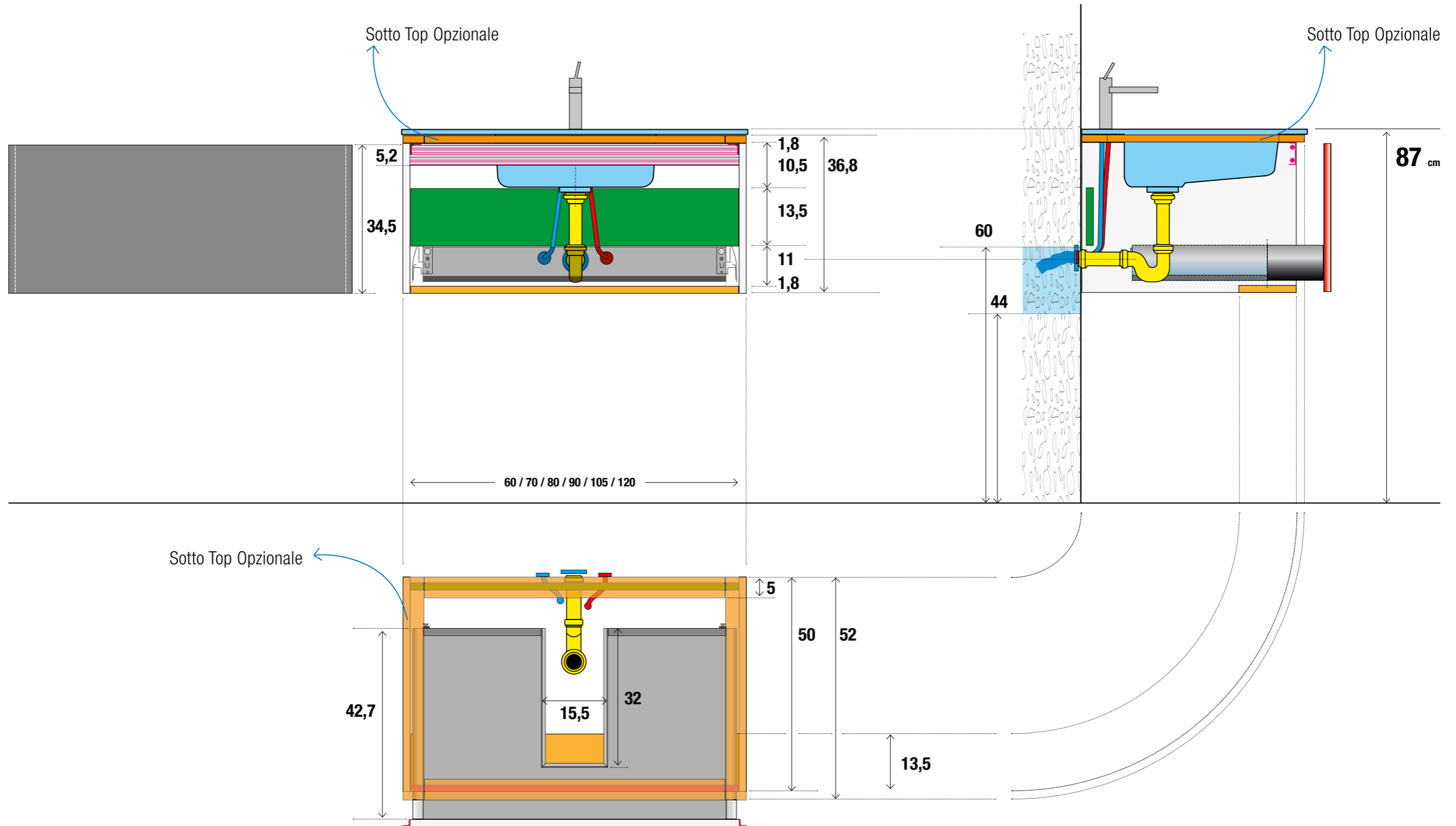

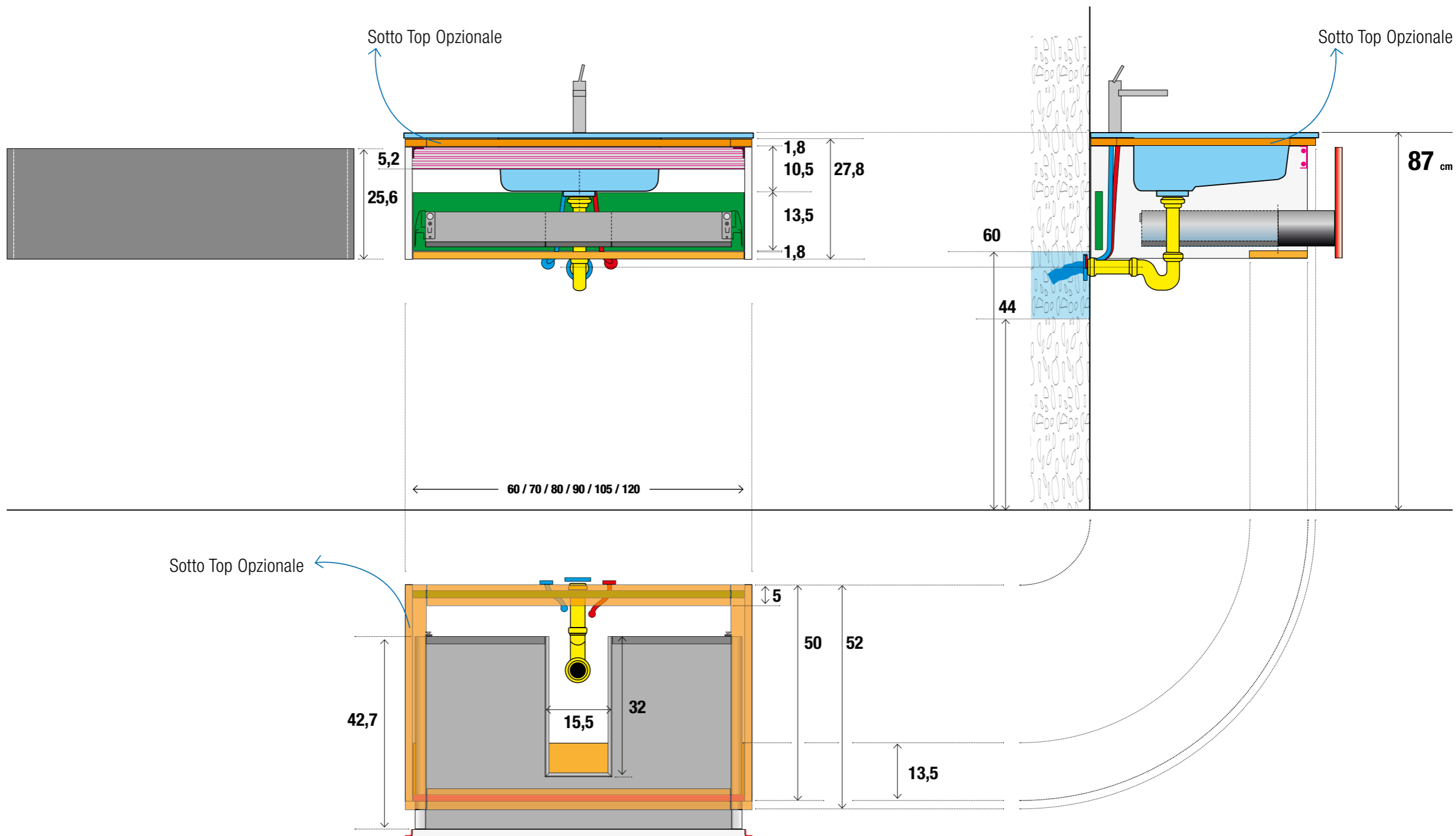

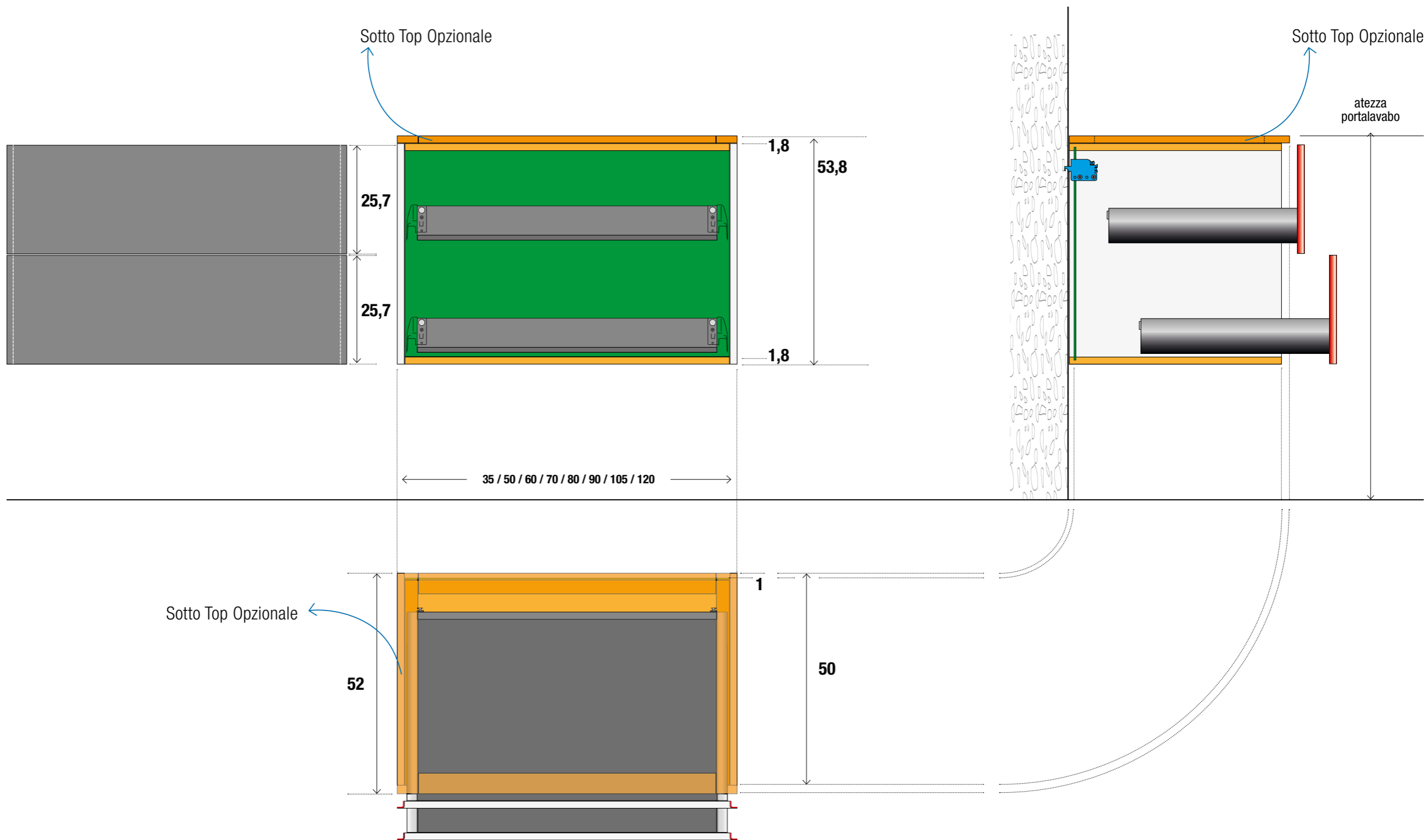

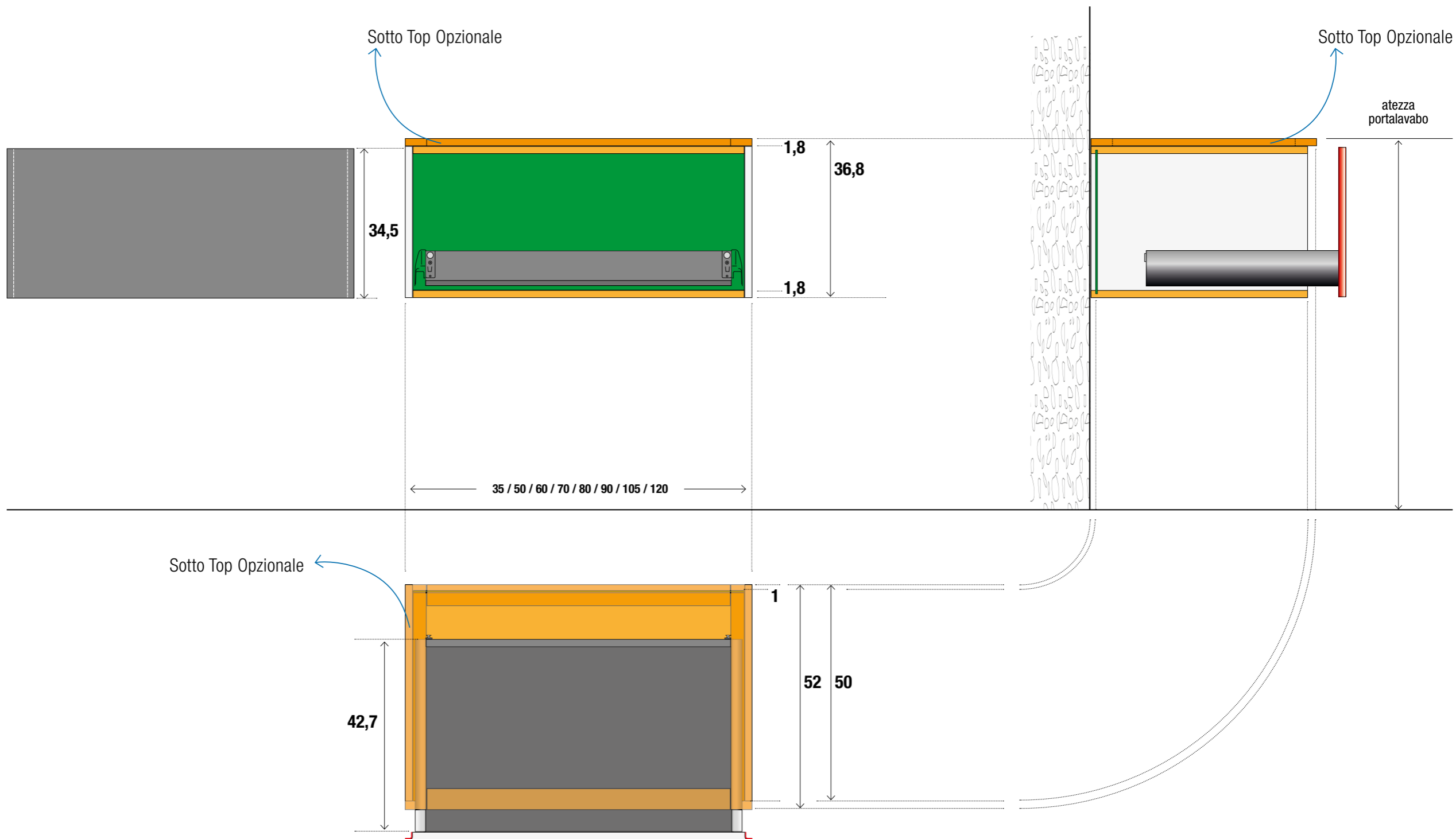

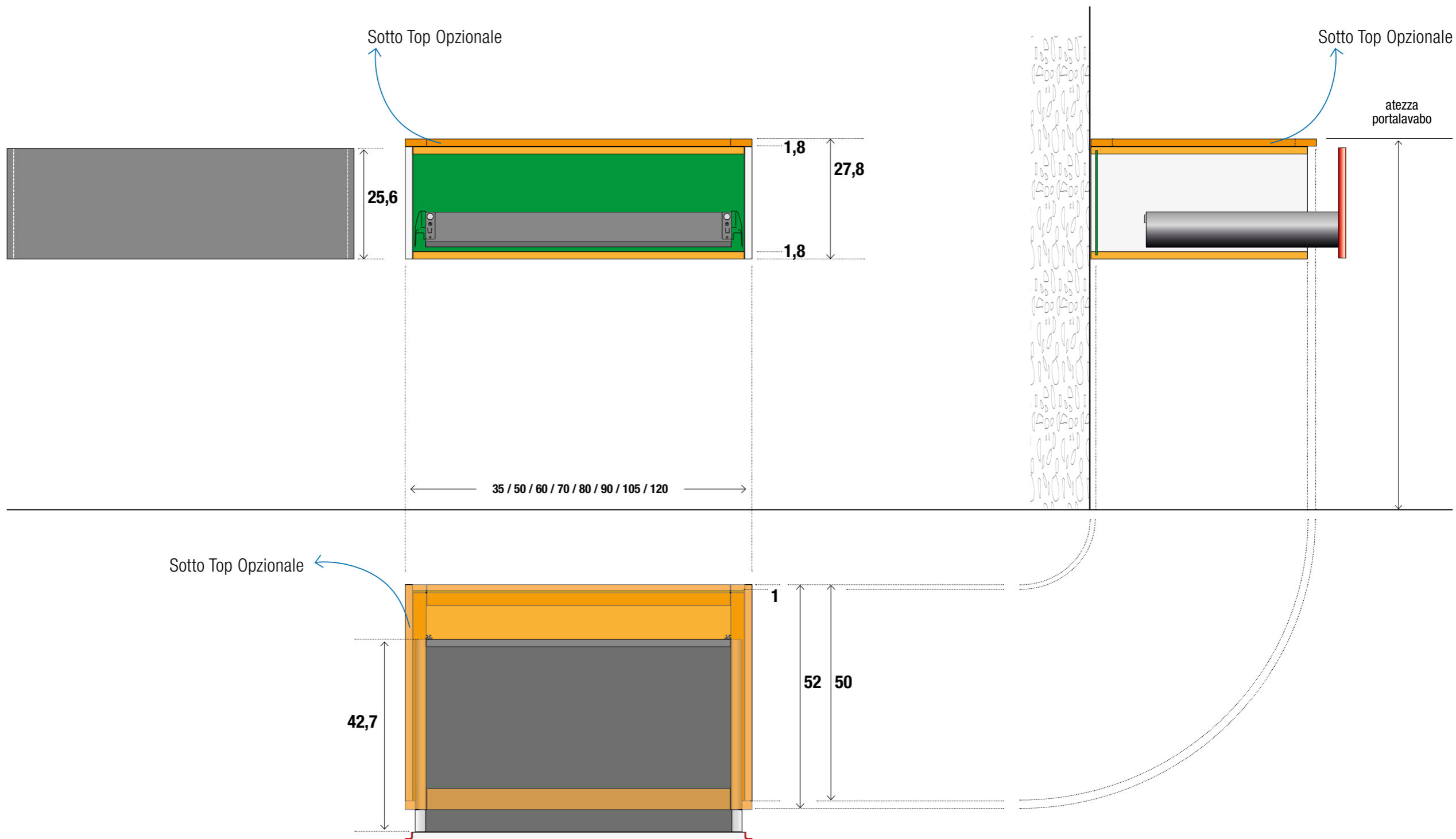

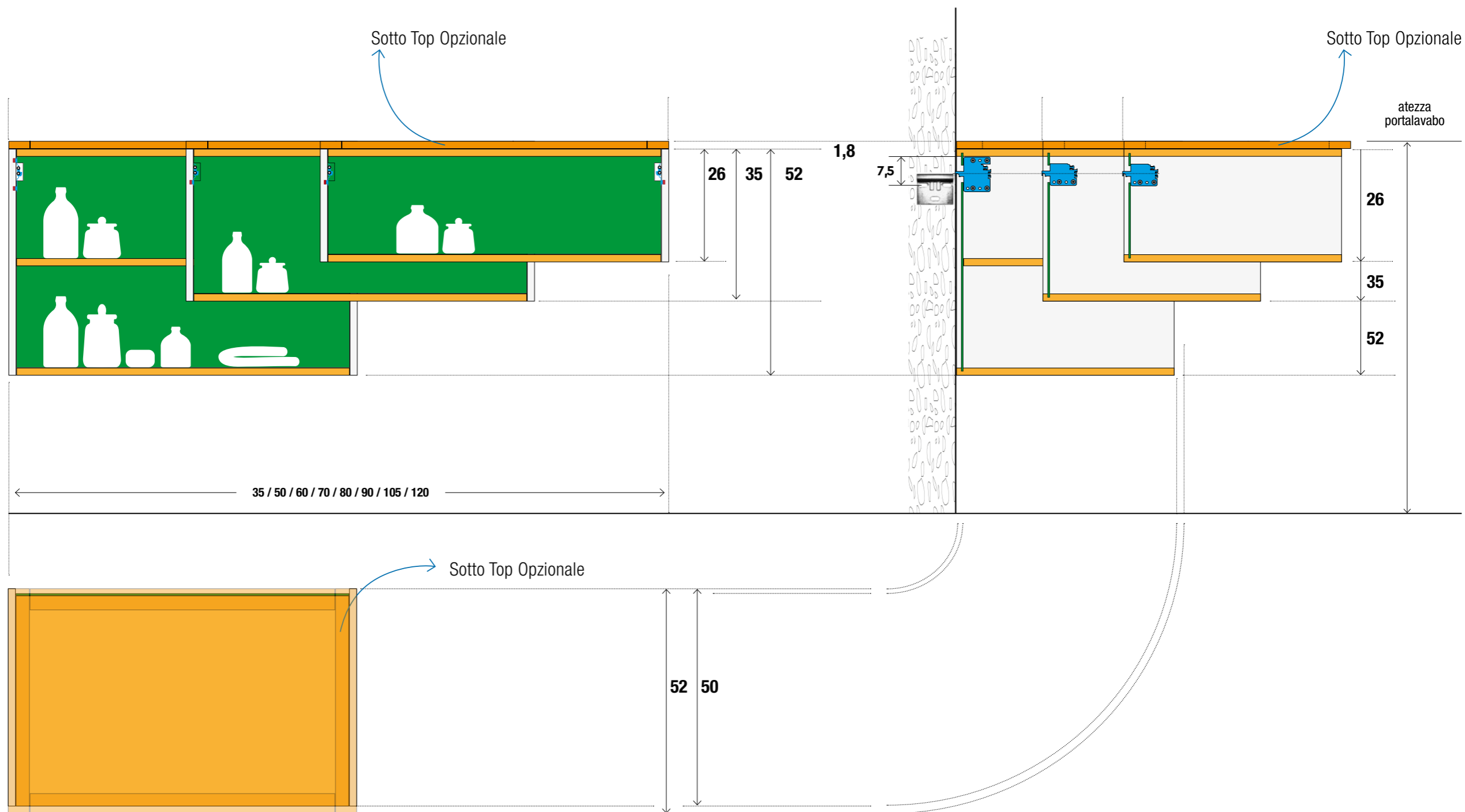

Sotto Top Opzionale

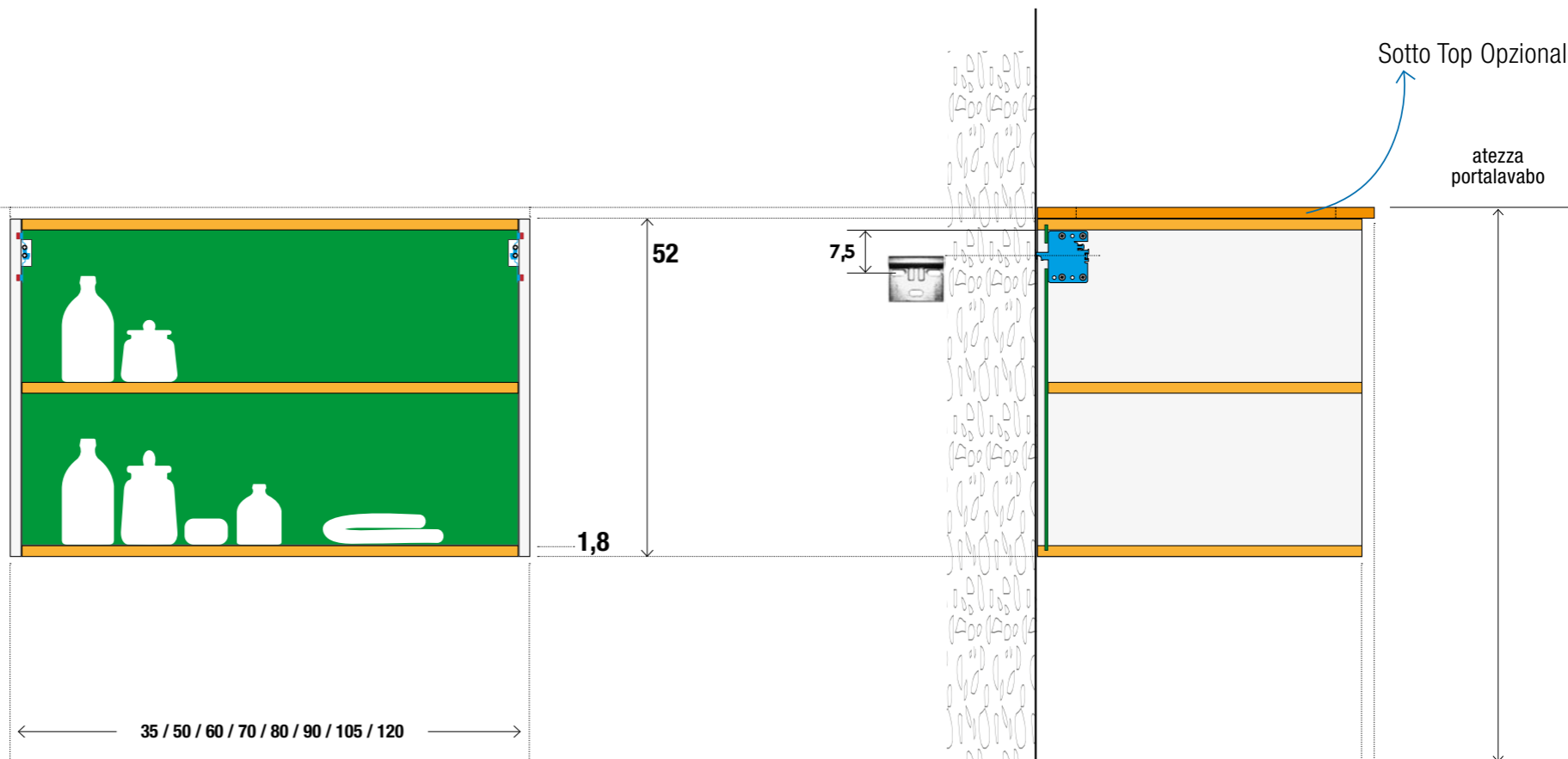

Sotto Top Opzionale

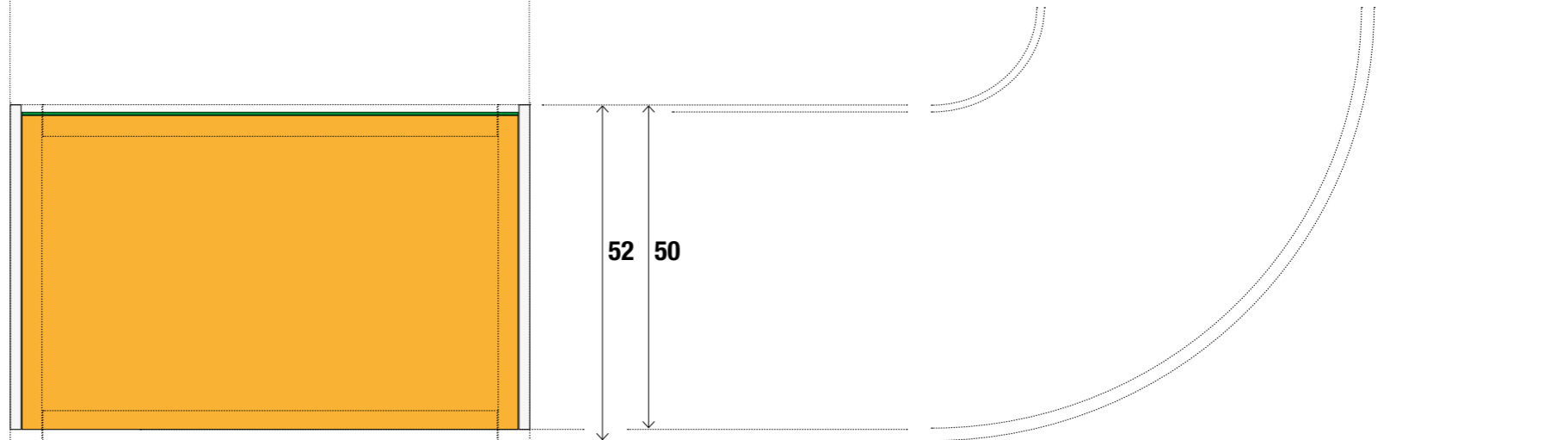
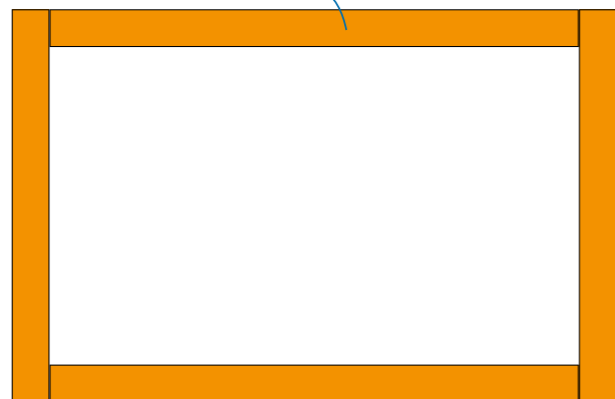

Sotto Top Opzionale

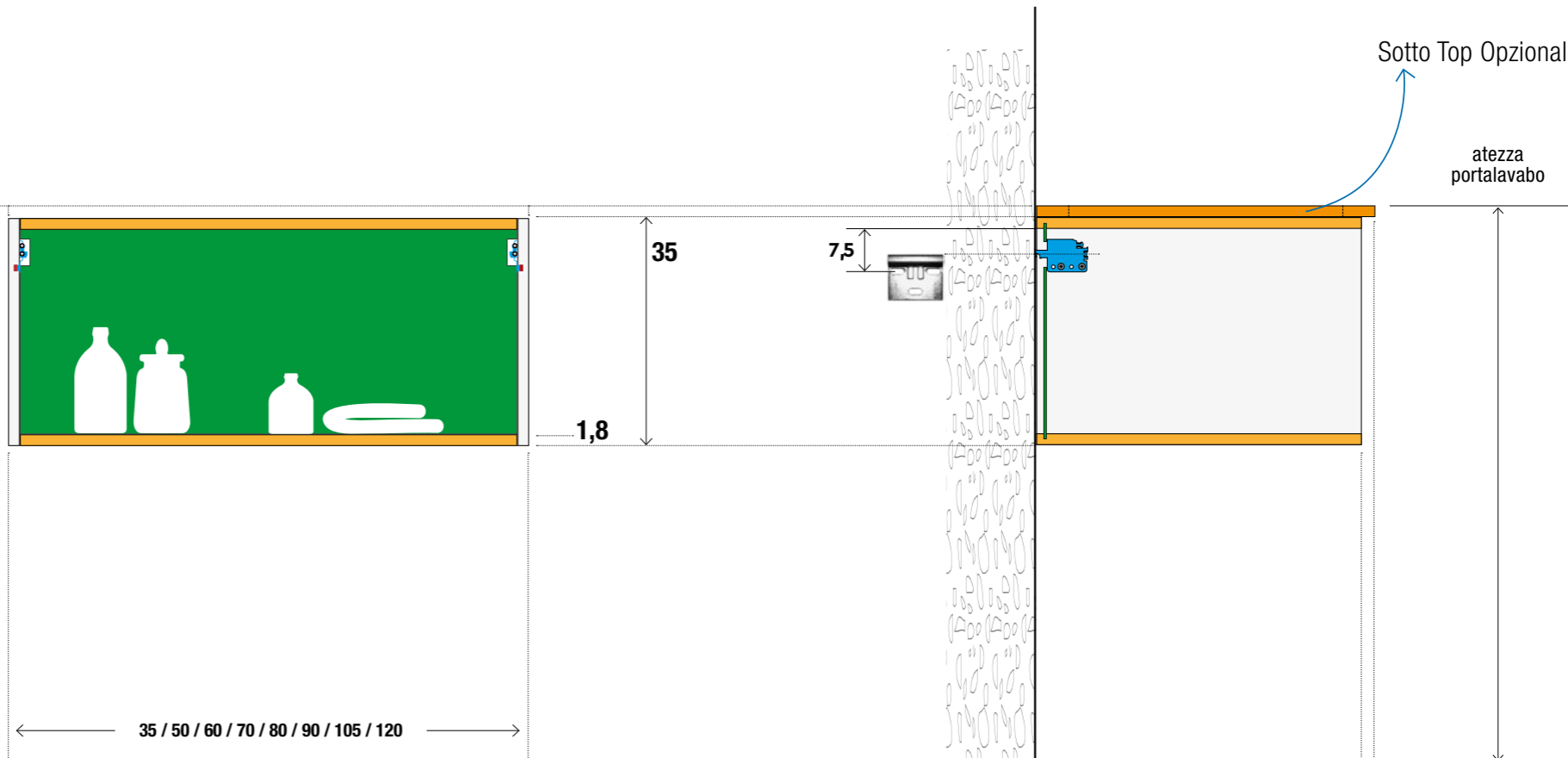

Sotto Top Opzionale

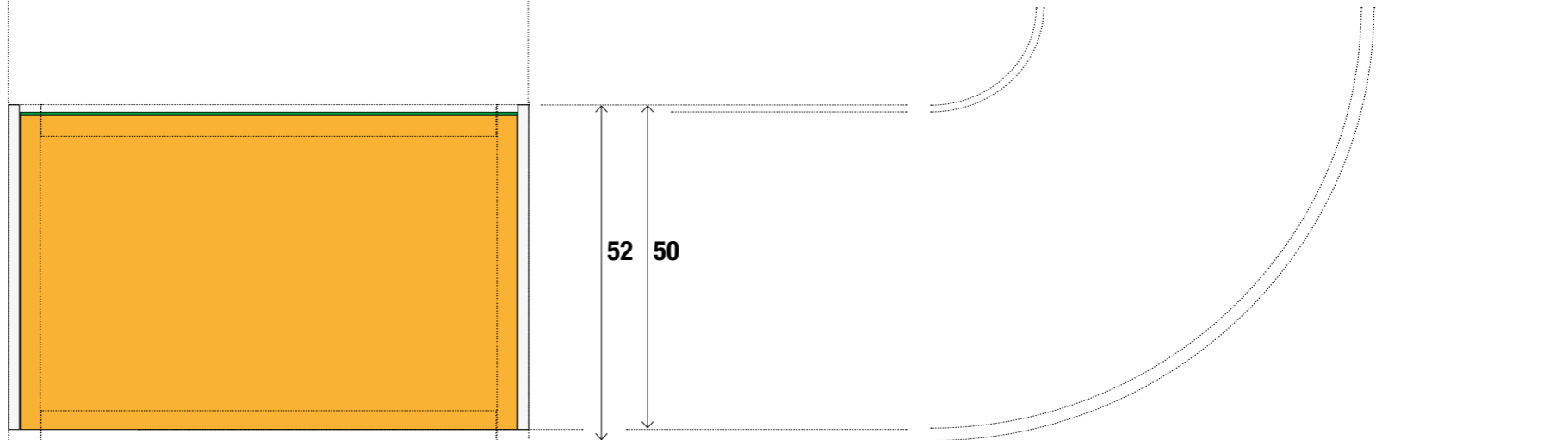

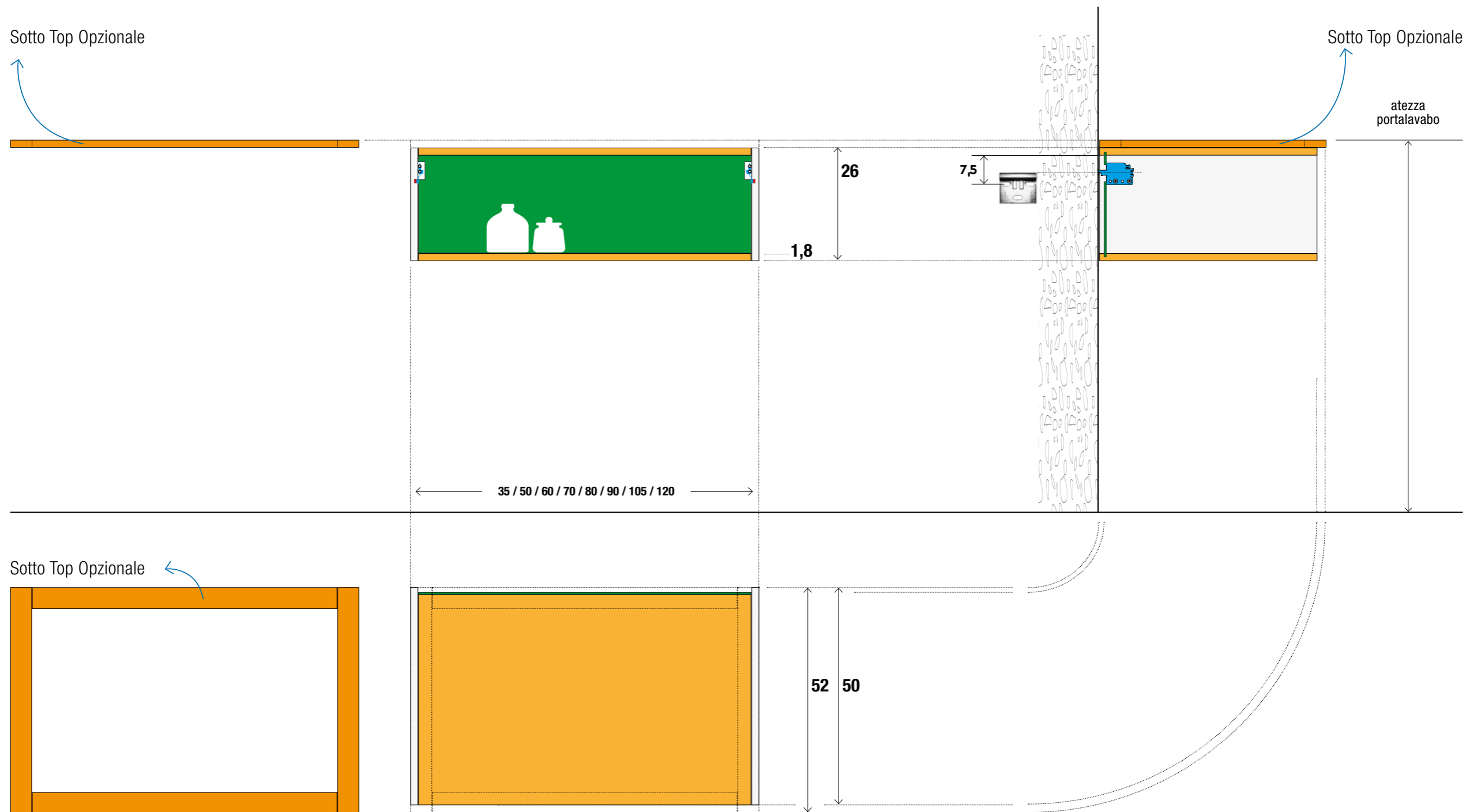

Sotto Top Opzionale

Preso maniglia laterale



GB GROUP
The art of bathroom

61040 Sant'Ippolito (PU) Italy
Via Riva Tarugo, 29
t. +39 0721 728214 f. +39 0721 728609
info@gbgroupe.com www.gbgroupe.com

